



READ THIS MANUAL CAREFULLY!
It contains important safety information.
Keep it for future reference.

SUPER SIX

Owner's Manual Supplement 120858.PDF

Please note that the specifications and information in this manual are subject to change for product improvement. For the latest product information, go to <http://www.cannondale.com/tech/>.

SAFETY INFORMATION

About This Supplement

Cannondale Owner’s Manual Supplements provide important model specific safety, maintenance, and technical information. They are not replacements for your *Cannondale Bicycle Owner’s Manual*.

This supplement may be one of several for your bike. Be sure to obtain and read all of them.

If you need a manual or supplement, or have a question about your bike, please contact your Cannondale Dealer immediately, or call us at one of the telephone numbers listed on the back cover of this manual.

You can download Adobe Acrobat PDF versions of any Cannondale Owner’s Manuals or Supplements from our website: <http://www.cannondale.com/bikes/tech>.

- This manual is not a comprehensive safety or service manual for your bike.
- This manual does not include assembly instructions for your bike.
- All Cannondale bikes must be completely assembled and inspected for proper operation by a Cannondale Dealer before delivery to the owner.

 **WARNING**

This supplement may include procedures beyond the scope of general mechanical aptitude.

Special tools, skills, and knowledge may be required. Improper mechanical work increases the risk of an accident. Any bicycle accident has risk of serious injury, paralysis or death. To minimize risk we strongly recommend that owners always have mechanical work done by an authorized Cannondale retailer.

Important Composites Message

Your bike is made from composite materials also known as “carbon fiber.”

All riders must understand a fundamental reality of composites. Composite materials constructed of carbon fibers are strong and light, but when crashed or overloaded, carbon fibers do not bend, they break.

For your safety, as you own and use the bike, you must follow proper service, maintenance, and inspection of all the composites (frame, stem, fork, handlebar, seat post, etc.) Ask your Cannondale Dealer for help.

We urge you to read PART II, Section D. “Inspect For Safety” in your Cannondale Bicycle Owner’s Manual BEFORE you ride.

 **WARNING**

**YOU CAN BE SEVERELY INJURED,
PARALYZED OR KILLED IN AN ACCIDENT
IF YOU IGNORE THIS MESSAGE.**

Intended Use

The intended use of your bike or frameset is
CONDITION 1 / HIGH PERFORMANCE ROAD.



CONDITION 1 / HIGH-PERFORMANCE ROAD bikes and framesets are designed for riding on a paved surface where the tires do not lose ground contact. They are not intended to be ridden off-road, cyclocross, or touring with racks or panniers.

Material use is optimized to deliver both light weight and specific performance. You must understand that (1) these types of bikes are intended to give an aggressive racer or competitive cyclist a performance advantage over a relatively short product life, (2) a less aggressive rider will enjoy longer frame life, (3) you are choosing light weight (shorter frame life) over more frame weight and a longer frame life, (4) you are choosing light weight over more dent resistant or rugged frames that weigh more. All frames that are very light need frequent inspection for cracks that would indicate that the frame is worn out from fatigue. These frames are likely to be damaged or broken in a crash. They are not designed to take abuse or be a rugged workhorse.

WARNING

UNDERSTAND YOUR BIKE AND ITS INTENDED USE. CHOOSING THE WRONG BICYCLE FOR YOUR PURPOSE CAN BE HAZARDOUS. USING YOUR BIKE THE WRONG WAY IS DANGEROUS.

Industry usage Conditions 1 - 5 are generalized and evolving. Consult your Cannondale Dealer about how you intend to use your bike.

Please read your *Cannondale Bicycle Owner's Manual* for more information about Intended Use and Conditions 1-5.

Maximum Weight Limit

RIDER lbs / kg	LUGGAGE * lbs / kg	TOTAL lbs / kg
275 / 125	10 / 4.5	285 / 129

* Seat Bag /Handlebar Bag Only

Building Up A Frameset

Before building up a frameset, consult with your Cannondale Dealer and the component manufacturers, and discuss your riding style, ability, weight, and interest in and patience for maintenance.

Make sure the components chosen are compatible with your bike and intended for your weight and riding style.

Generally speaking, lighter weight components have shorter lives. In selecting lightweight components, you are making a trade-off, favoring the higher performance that comes with less weight over longevity. If you choose more lightweight components, you must inspect them more frequently. If you are a heavier rider or have a rough, abusive or "go for it" riding style, buy heavy duty components.

Read and follow the component manufacturers warnings and instructions.

Bike Stands

The clamping jaws of an ordinary bike stand can generate a crushing force strong enough to seriously damage and ruin your bike frame.

CAUTION

Never place your bike in a bike stand by clamping the frame. Place your bike in a stand by extending the seat post and positioning the stand clamp on the extended seat post. Don't extend beyond the MINIMUM INSERT line marked on the seat post.

Since your carbon seat post can also be damaged by clamping force, adjust the stand clamp for the minimum clamping force needed to secure the bike.

Its a good idea to remove your current seat post and use an old one when mounting your bike in a stand.

Protect From Extreme Temperatures

- Protect your carbon bike from extreme temperatures when storing or transporting it.
- Allow your bike to cool off or warm up before you ride
- Do not store your bike in places where the temperature will exceed 66.5C° (150°F). For example, do not leave your bike lying flat in a black pickup truck bed in the desert sun, or, under the glass of a hatchback auto.

Inspection & Crash Damage of Carbon Frames

WARNING

AFTER A CRASH OR IMPACT:

Inspect frame carefully for damage (See PART II, Section D. Inspect For Safety in your Cannondale Bicycle Owner's Manual.)

Do not ride your bike if you see any sign of damage, such as broken, splintered, or delaminated carbon fiber.

ANY OF THE FOLLOWING MAY INDICATE A DELAMINATION OR DAMAGE:

An unusual or strange feel to the frame

Carbon which has a soft feel or altered shape

Creaking or other unexplained noises,

Visible cracks, a white or milky color present in carbon fiber section

Continuing to ride a damaged frame increases the chances of frame failure, with the possibility of injury or death of the rider.

Repainting Or Refinishing

You should not paint over the existing finish, refinish or repaint your bike. The carbon fiber composites making up the frame are held together by some extremely strong bonding chemicals. However, these bonds can be attacked or weakened by paint stripping or refinishing chemicals.

WARNING

Repainting, painting over, retouching, or refinishing your frame or fork can result in severe damage leading to an accident. You can be severely injured, paralyzed or killed.

Refinishing chemicals : Solvents, and strippers can attack, weaken, or destroy the important composite chemical bonds holding your frame together.

Using abrasives or sanding the frame/fork structure, original paint, decals, or coatings through the use of mechanical actions such as plastic or glass bead blasting or other abrasive methods such as sanding or scraping can remove frame material or weaken it.

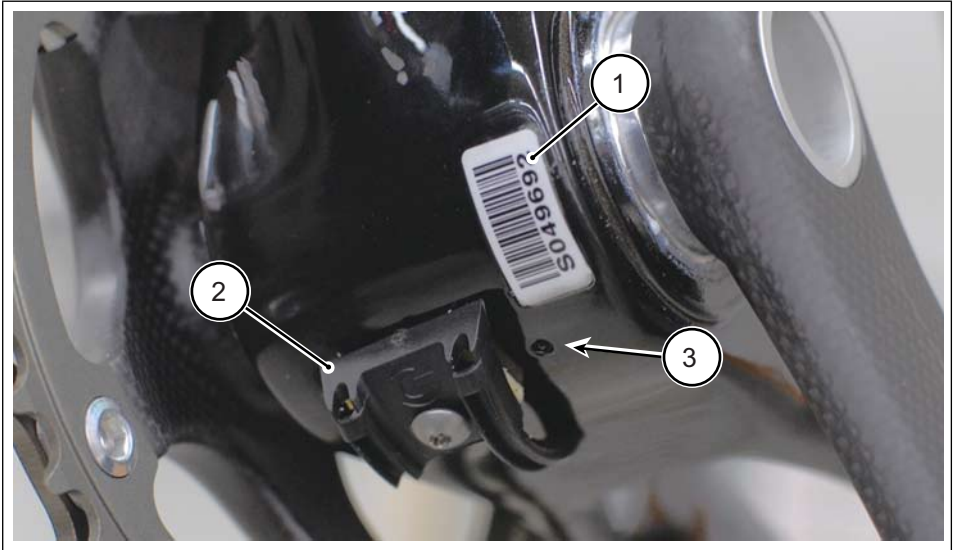

Figure 2.

Serial Number

The serial number (1) printed and permanently affixed barcode label.

Use this serial number for warranty registration and theft recovery. See your *Cannondale Bicycle Owner's Manual* for more information on warranty registration.

Bottom Bracket Guide

The cable guide (2) is mounted on the bottom bracket. Replacements are available through a Cannondale Dealer. The kit # is KF363/

Vent

Keep the small vent hole (3) in the bottom of the bottom bracket shell clear of any dirt so that any water can drain out.

Water can enter into frame tubes through washing, condensation, wet rides, or rain. It penetrates or can be sprayed in through water bottle bosses, seat tube, head tube and seat post openings.

Water will not chemically harm your bike. If it freezes, the ice expansion can burst or crack the frame making it unsafe to ride. This damage is NOT covered under your warranty.

After wet rides, remove seat post, invert bike to drain any water.

HEADSET

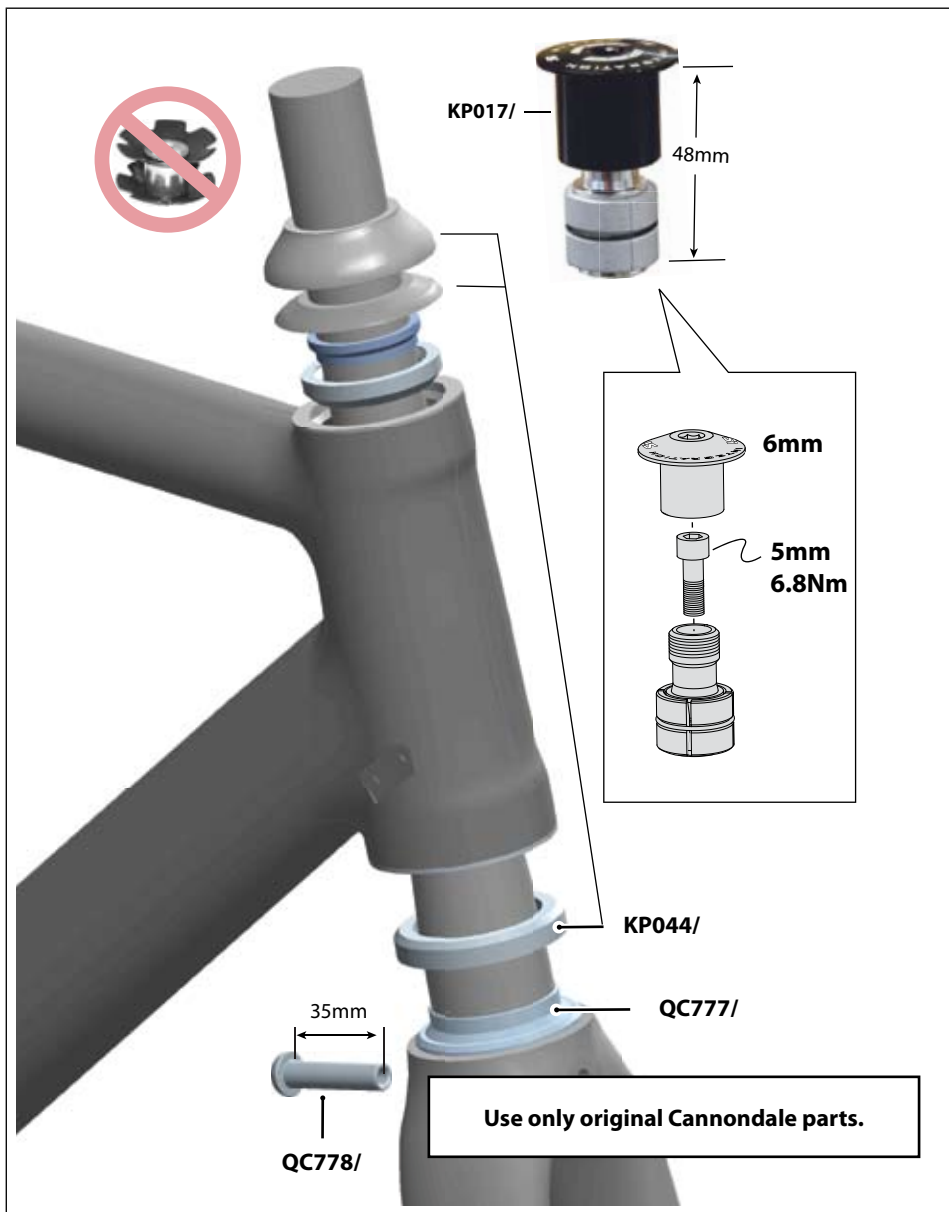

Figure 3.

SEAT POST / BINDER



Figure 4.

Installation

1. Make sure the seat post, binder, and seat tube are clean. Use a dry towel.
2. Apply small amount of seat post gel to seat post surface and reinstall the post into the seat tube.
4. Tighten the seat binder with a torque wrench. **DO NOT EXCEED MAXIMUM SPECIFIED TORQUE 6.8Nm.**
5. Check tightening torques of the saddle to seat post clamp bolts. Too much torque may fail the bolts. Too little torque will result in movement which leads to fatigue and bolt failure.

WARNING

TO AVOID SEAT POST OR FRAME DAMAGE:

- Follow seatpost manufacturer's instructions
- Use a torque wrench to tighten.
- Use only seat post gel to lubricate.
- Do not use solvents, or chemical spray cleaners to clean.
- Never force a seat post into the seat tube.
- After any crash, fall, or impact, remove and inspect the seat post for damage (e.G., Cracks, scratches, scrapes, gouges, splintering). If damage is found, do not ride it; discard it. Replace the seat post with a new one.

YOU CAN BE SEVERELY INJURED, PARALYZED OR KILLED IF YOU IGNORE THESE WARNINGS.

BOTTOM BRACKET SHELL

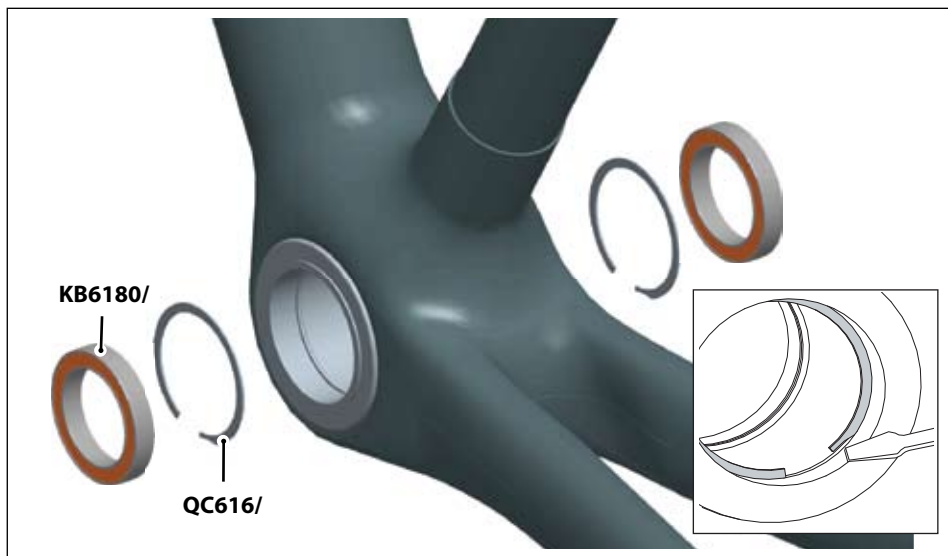

Figure 5.

Crankset Compatibility

The BB shell is compatible with the BB30 Standard. See <http://www.bb30standard.com/> For information See *SI Cranksets Owner's Manual Supplement*. See <http://www.cannondale.com/tech/>.

Bearing Maintenance

Shell bearings (KB6180/) are sealed cartridge type and do not require lubrication. Inspect bearing condition annually (at a minimum) and anytime the crankset assembly is disassembled or serviced. The bearings are a press fit within the shell. Old bearings should not be reinstalled if removed. Replace both bearings at the same time.

Replacements circlips (QC616/) are available if the circlips become damaged. The circlips can be lifted from the BB groove (inset) by lifting the hooked end with a thin blade screwdriver.

CAUTION

DO NOT FACE, MILL OR MACHINE THE BOTTOM BRACKET SHELL FOR ANY REASON.

Doing so can result in serious damage and possibly a ruined bike frame.

BB30-to-68mm Standard Adapter

The adapter (Cannondale kit KF365/) converts the BB30 bottom bracket cranksets for use with 68mm bottom brackets. Once installed, the adapter can not be removed.

The adapter IS NOT a repair part and will only work in undamaged frames in good condition. Improper installation or removal can result in damage and void applicable frame warranty.

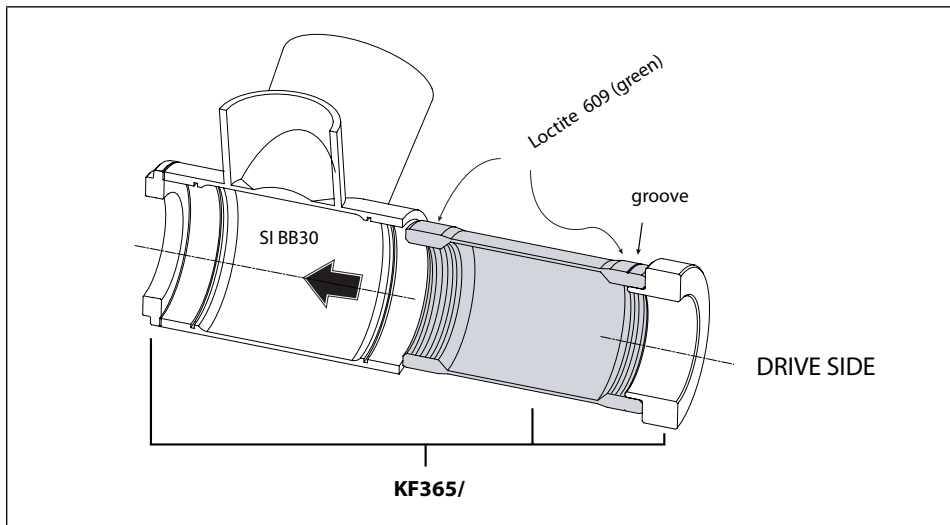

Figure 6.

CAUTION

SERIOUS FRAME DAMAGE

Once installed, the SI-to-Standard adapter is a non-removable/ permanent frame part. Do not remove it. Adapters must be installed by a professional bike mechanic.

Cannondale Tools

KT011/ is a bearing removal tool. KT010/ is a set of bearing installation tools to be used with a standard headset press. KT013/ a two piece tool set required for removing the crankarms SI Hollowgram alloy cranksets.

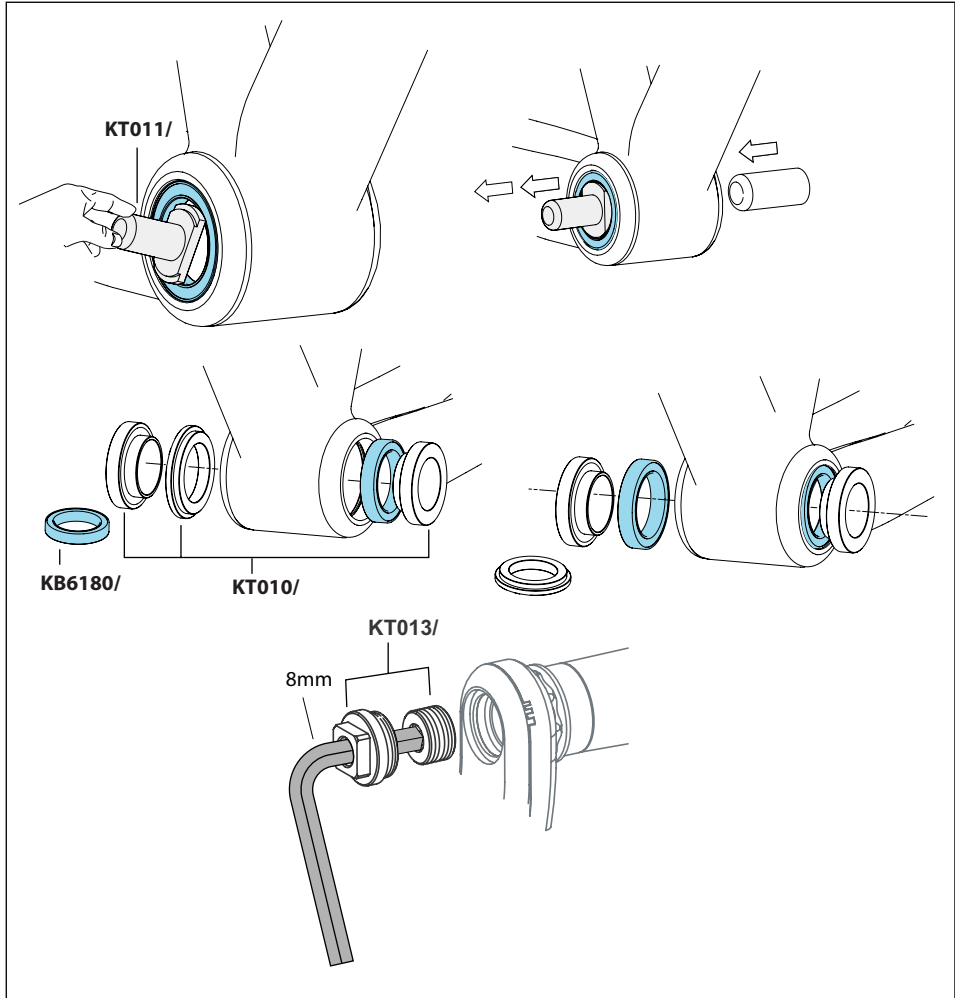

Figure 7.

CHAINSTAY PROTECTION

The chainstay plate located on the right chainstay just behind the chainrings, protects the chainstay from damage in the event the chain is dropped from the chainring. Contact your Cannondale Dealer for a replacement if it becomes missing or damaged.



Figure 8.

The clear chainstay protector provides limited protection against frame or finish damage caused by the chain. Replacement protectors are available through a Cannondale Dealer.



Figure 9.

DERAILLEUR HANGER

Before re-installing (same or new): Clean dropout and inspect carefully for any cracks or damage. Clean surfaces and apply a light film of bike grease to the dropout to minimize any noise or “creaking” that might result from very slight movement between the dropout and hanger during movement of the derailleur. Apply grease and Loctite carefully. Do not contaminate the male or female bolt threads with grease which would cause the Loctite to be ineffective.

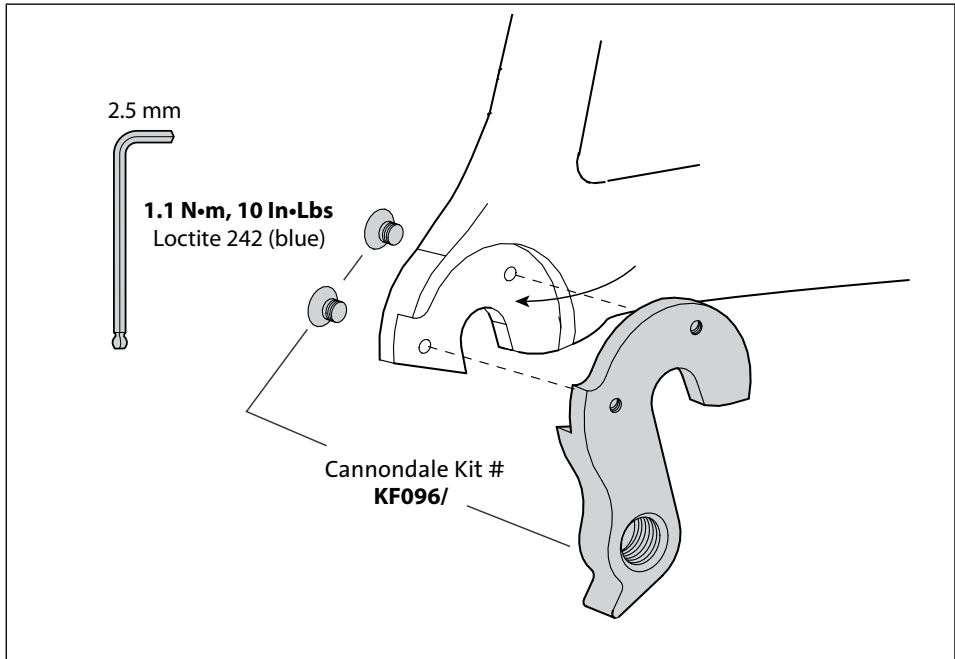

Figure 10.

Check derailleur adjustment after replacement. Readjust wheel quick release so it is very tight. See PART I Section 4. A in your Cannondale Bicycle Owner's Manual.

CAUTION

DO NOT USE A DERAILLEUR HANGER ALIGNMENT TOOL TO STRAIGHTEN.

GEOMETRY/SPECIFICATION

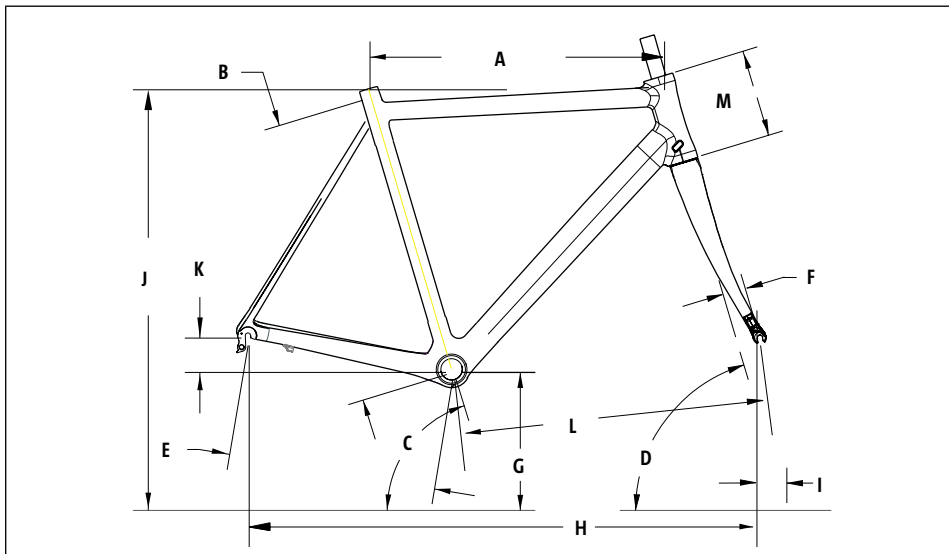

ITEM		48	50	52	54	56	58	60	63
Horizontal Top Tube Length (cm)	A	51.5	52.5	53.5	54.5	56.0	57.5	59.0	60.0
Measured Size (cm)*	B	46	48	50	52	54	56	58	61
Seat Tube Angle	C	74.5°	74.5°	74°	73.5°	73.5°	73°	72.5°	72°
Head Tube Angle	D	72°	72.5°	73°	73°	73°	73.5°	73.5°	73.5°
Chainstay Length	E	40.5	40.5	40.5	40.5	40.5	40.5	40.8	40.8
Fork Rake	F	4.5	4.5	4.5	4.5	4.5	4.5	4.5	4.5
Bottom Bracket Height (cm)	G	26.5	26.5	26.5	26.8	26.8	27.0	27.0	27.0
Wheelbase (cm)	H	95.9	96.6	96.8	97.5	99.2	99.6	100.1	101.3
Trail (cm)	I	6.2	5.9	5.6	5.6	5.6	5.3	5.3	5.3
Standover @ Top Tube Midpoint	J	74	75.3	76.5	78.5	80.1	82.2	83.8	86.6
Bottom Bracket Drop (cm)	K	7.2	7.2	7.2	6.9	6.9	6.7	6.7	6.7
Front Center Distance (cm)	L	56.5	57.2	57.4	58.0	59.7	60.1	61.0	61.4
Head Tube Length (cm)	M	11.0	11.5	12.0	14.0	15.5	17.5	19.0	22.0
Headset Compression Assy	Cannondale SI Compression Assembly - KP017/								
Seatpost Dia.	31.6mm								
Seat Binder	SIZE 34.9mm				MAXIMUM TORQUE 6.8Nm				
Front Derailleur Clamp Dia.	SIZE 34.9mm clamp-on				MAXIMUM TORQUE 6.8Nm				
Dropout Spacing	Rear 130mm, Front 100mm								

* The measured size is from the center of the bottom bracket to the top of the top tube along the seat tube axis. All sizes have a slightly sloping top tube.

REPLACEMENT PARTS

ORDER		
KF363/	BB CABLE GUIDE w/fixing bolt	
KF055/	INLINE ADJUSTER (QTY 2)	
KF362/BBQ	SEAT BINDER 34.9mm	
KF115/	SEAT POST GEL	
KP045/	CHAINSTAY PROTECT-SUPERSIX	
ORDER	HEADSET & FORK PARTS	
KP043/	FORK SUPER SIX	
KP044/	HEADSET SUPER SIX	
QC777/	CROWN RACE	
QC778/	BRAKE BOLT(35mm)	
KP017	SI COMPRESSION ASSY	
ORDER	SI BB30	
KB6810/	BEARINGS (QTY 2)	
QC616/	CIRCLIPS (QTY 2)	
KF096/	REAR DERAILLUER HANGER	
KP009/	KIT, ADAPTER, SIBB TO 68mm TAP	
KF365/	SI ADAPTER W/ SET	
KF366/	SI ADAPTER EXTRACTION TOOL SET	
<p>For an up to date list of kits available for your bike, please visit our Tech Center at : http://www.cannondale.com/bikes/tech/</p>		

OWNER NOTES

Record maintenance history, service information here.

DATE	WORK PERFORMED